

Coaxial Frequency Mixer

Level 13 (LO Power +13 dBm) 50 to 1000 MHz

ZP-2MH+ ZP-2MH



BNC version shown
CASE STYLE: GG60

Connectors	Model
BNC	ZP-2MH(+)
SMA	ZP-2MH-S(+)

+RoHS Compliant

The +Suffix identifies RoHS Compliance. See our web site for RoHS Compliance methodologies and qualifications

Maximum Ratings

Operating Temperature	-55°C to 100°C
Storage Temperature	-55°C to 100°C
RF Power	200mW
IF Current	40mA
Permanent damage may occur if any of these limits are exceeded.	

Coaxial Connections

LO	L
RF	R
IF	X

Outline Drawing

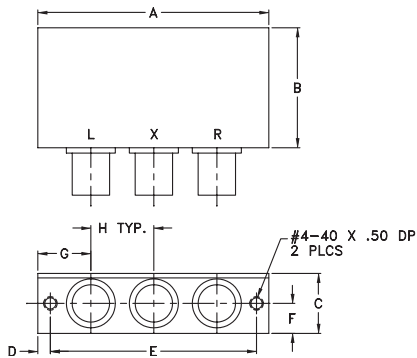

Outline Dimensions (inch/mm)

A	B	C	D	E	F	G	H	wt
2.31	1.20	.60	.125	2.062	.30	.53	.63	grams
58.67	30.48	15.24	3.18	52.37	7.62	13.46	16.00	75.0

Features

- low conversion loss, 6.0 dB typ.
- wideband, 50 to 1000 MHz
- excellent L-R isolation, 47 dB typ., L-I, 47 dB typ.
- rugged shielded case

Applications

- VHF/UHF
- cellular
- instrumentation

Electrical Specifications

FREQUENCY (MHz)	CONVERSION LOSS (dB)	LO-RF ISOLATION (dB)					LO-IF ISOLATION (dB)													
		Mid-Band m		Total Range Max.			L		M		U		L		M		U			
LO/RF f_L-f_U	IF \bar{X} σ Max.	\bar{X}	σ	Max.	Total Range Max.	Typ.	Min.	Typ.	Min.	Typ.	Min.	Typ.	Min.	Typ.	Min.	Typ.	Min.	Typ.	Min.	
50-1000	DC-1000	6.0	0.25	7.5	9.0	58	40	47	30	37	25	55	35	47	20	32	18			

1 dB COMP.: +9 dBm typ.

L = 50-100 MHz M = 100-500 MHz U = upper range [$f_U/2$ to f_U]
m = mid band [$2f_L$ to $f_U/2$]

Typical Performance Data

Frequency (MHz)	Conversion Loss (dB)	Isolation L-R (dB)	Isolation L-I (dB)	VSWR RF Port (:1)	VSWR LO Port (:1)
50.00	80.00	5.81	57.10	55.26	1.03
100.00	70.00	5.85	51.37	49.62	1.05
129.17	99.17	5.79	49.27	47.63	1.07
200.00	170.00	5.74	46.10	44.54	1.10
208.33	178.33	5.73	45.84	44.23	1.13
287.50	257.50	5.70	43.58	42.34	1.17
340.28	310.28	5.67	42.34	40.78	1.19
366.67	336.67	5.69	41.82	40.13	1.21
445.83	415.83	5.72	40.63	37.78	1.26
498.61	468.61	5.75	39.34	36.04	1.28
500.00	470.00	5.75	39.33	36.00	1.29
551.39	521.39	5.86	38.49	34.15	1.33
630.56	600.56	5.90	38.05	32.59	1.38
683.33	653.33	6.06	38.00	31.67	1.41
709.72	679.72	6.12	38.21	31.02	1.43
788.89	758.89	6.33	38.31	29.48	1.49
868.06	838.06	6.58	37.78	28.55	1.53
947.22	917.22	6.88	37.88	27.56	1.60
973.61	943.61	6.98	37.84	27.05	1.62
1000.00	970.00	7.05	37.64	26.57	1.64

Electrical Schematic

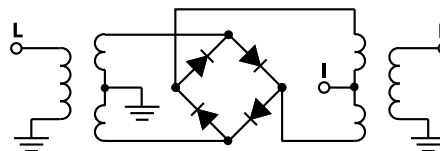

Notes

- Performance and quality attributes and conditions not expressly stated in this specification document are intended to be excluded and do not form a part of this specification document.
- Electrical specifications and performance data contained in this specification document are based on Mini-Circuit's applicable established test performance criteria and measurement instructions.
- The parts covered by this specification document are subject to Mini-Circuits standard limited warranty and terms and conditions (collectively, "Standard Terms"); Purchasers of this part are entitled to the rights and benefits contained therein. For a full statement of the Standard Terms and the exclusive rights and remedies thereunder, please visit Mini-Circuits' website at www.minicircuits.com/MCLStore/terms.jsp



Performance Charts

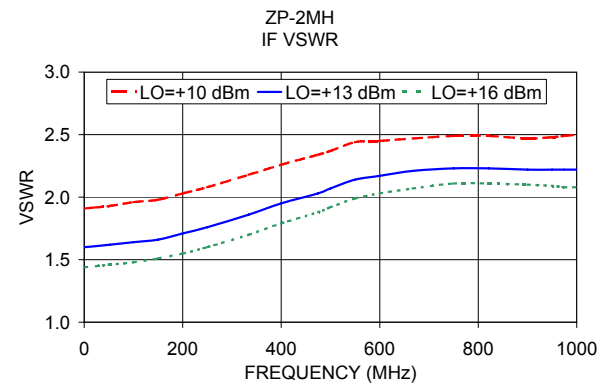
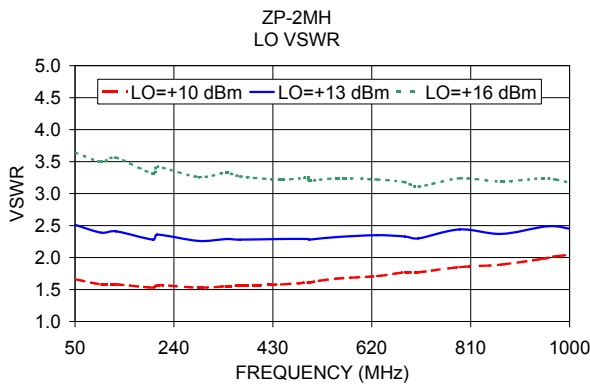
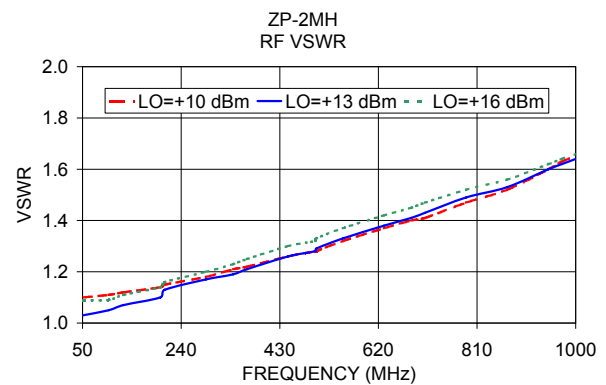
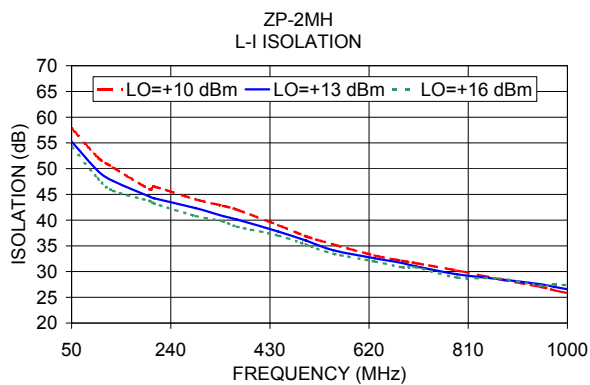
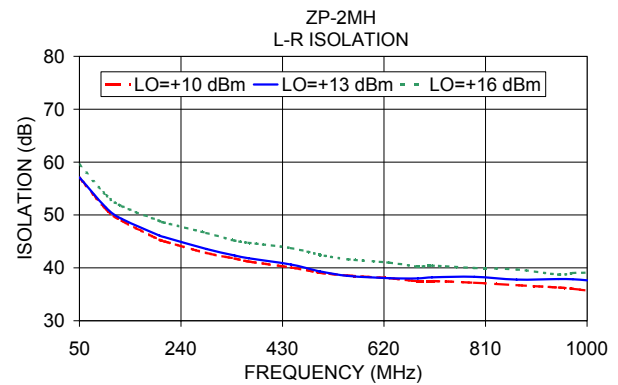
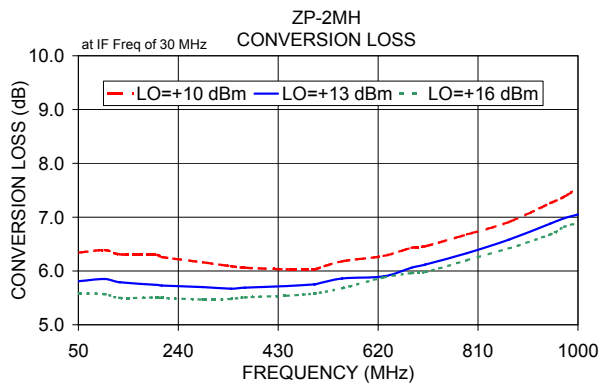

Notes

- Performance and quality attributes and conditions not expressly stated in this specification document are intended to be excluded and do not form a part of this specification document.
- Electrical specifications and performance data contained in this specification document are based on Mini-Circuit's applicable established test performance criteria and measurement instructions.
- The parts covered by this specification document are subject to Mini-Circuits standard limited warranty and terms and conditions (collectively, "Standard Terms"); Purchasers of this part are entitled to the rights and benefits contained therein. For a full statement of the Standard Terms and the exclusive rights and remedies thereunder, please visit Mini-Circuits' website at www.minicircuits.com/MCLStore/terms.jsp

